

Sliding system for concertina doors

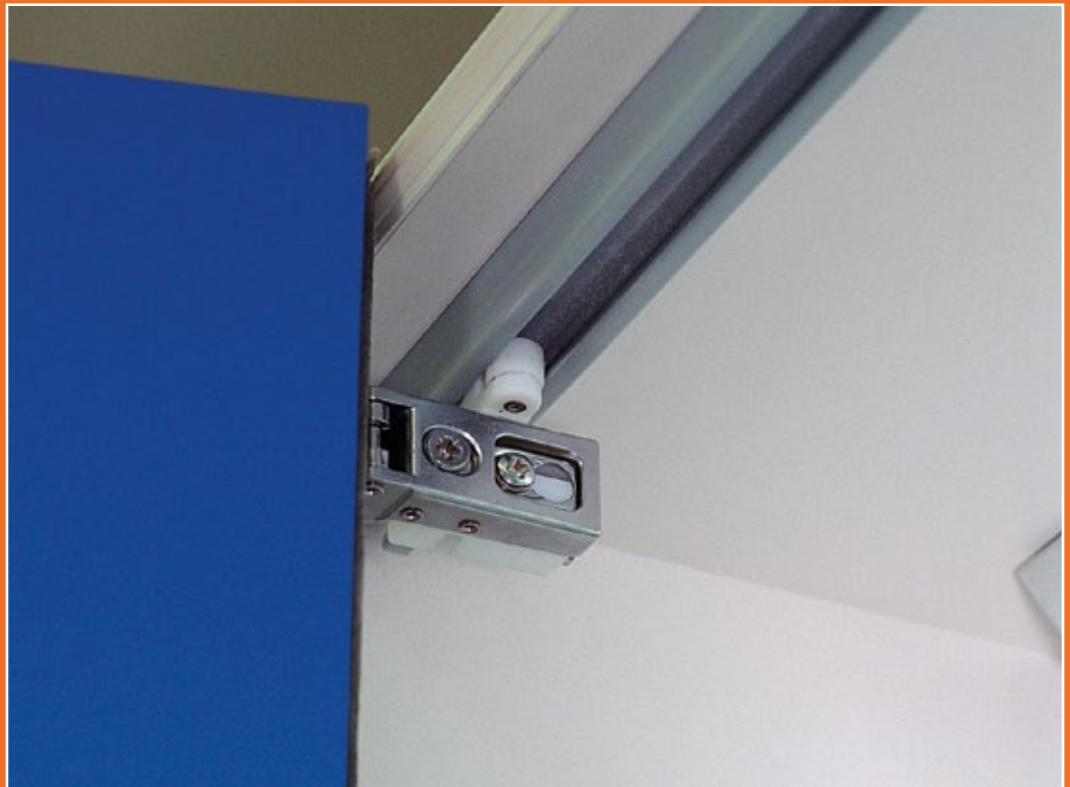

The Salice system for concertina doors has been designed to open both doors on one side only, giving good access to the interior of the cabinet.
Space taken up by the door in the maximum open position is reduced to a minimum (approximately 80 mm).



A nylon strip is available in order to prevent insertion of objects or fingers between doors. This also makes the system dustproof.



To ensure that the door closes fully and securely, particularly when there is some curvature of the door, a locating device is available.



F1C169

Hinge for sliding block

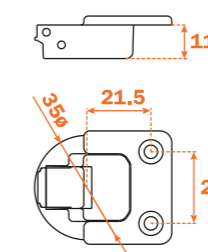

F1CZ69

For aluminium-framed doors

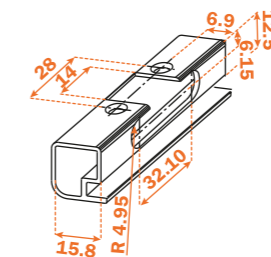

F1C069

Hinge for the Practical system of aluminium-framed doors



PracticAL

F1PVAY

Long sliding block
For aluminium-framed doors



F1PXAY

Sliding block



Central hinge

F1CXE9
screw-on

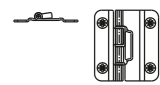

F1C0E9

knock-in
Dowels Ø 8x11.5

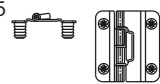

D206BK5

Central hinge for the Practical system of aluminium-framed doors.



PracticAL

Adhesive finger-protection strip

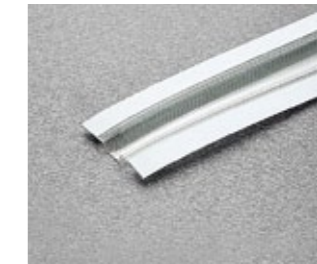

F1SBA1 white.
F1SBA3 black.
F1SBAY neutro.

F1RFAY

Locating device for door

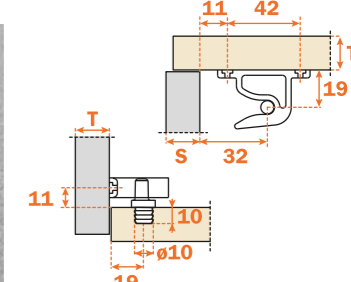

Calibrated height adjustment

Height adjustment of hinges assembled with the sliding components is achieved through a cam. Through this alignment a parallel movement of the component in the track is achieved. The result is a smooth movement without any binding.

ATTENTION! The sliding block does not have a load-bearing function. Therefore it must slide freely inside the track.

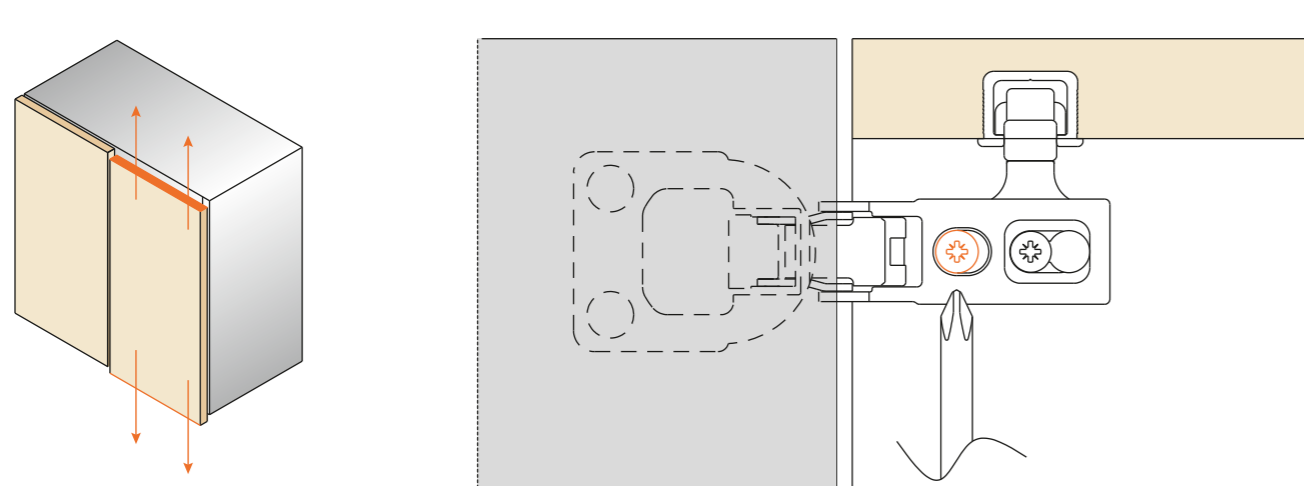

+2 mm -2 mm

Depth adjustment

Depth adjustment of the hinges mounted on the sliding component is achieved through the fixing screw of the same hinge.

Depth adjustment should be made in conjunction with the hinges mounted on the opposite door. This adjustment is useful to keep the "L" value constant all along front of the furniture.

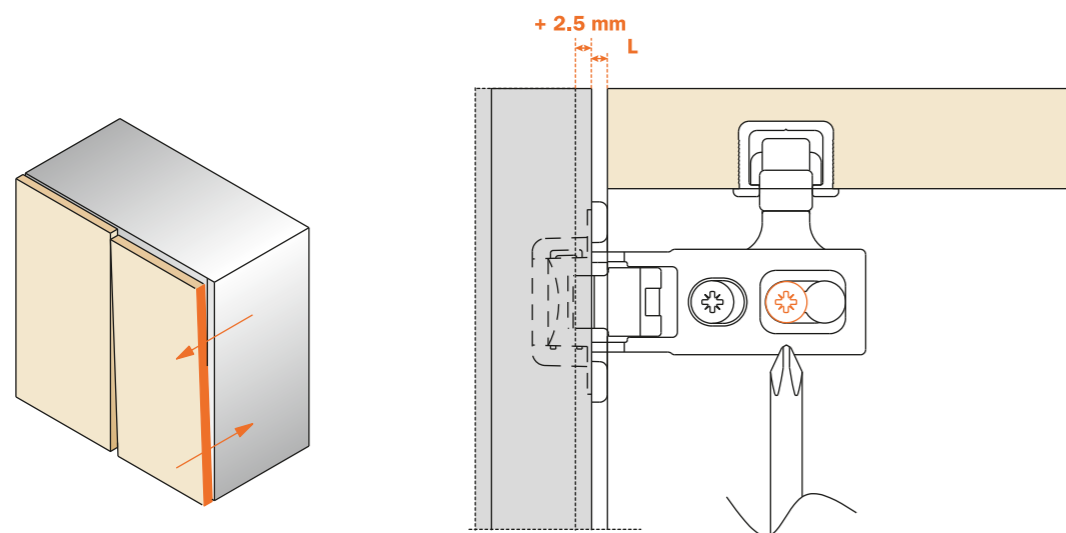

+2.5 mm

barb-fixed

screw-on B 3.5 DIN 7982

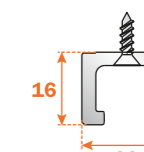
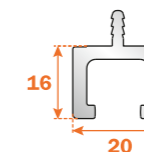
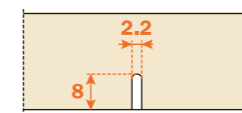

Colours	barb-fixed	screw-on B 3.5 DIN 7982
white	F1GIA1	F1GFA1
black	F1GIA3	F1GFA3
grey	F1GIAG	F1GFAG
beige	F1GIAP	F1GFAP

Standard lengths available: 590 mm, 880 mm, 1180 mm. Non-standard lengths can be supplied subject to a minimum order quantity of 900 pieces. The required length should be expressed in millimetres in the last four digits of the product code occupied by the dashes.

Mount the hinges of the fixed door on to the mounting plates on the cabinet side. We recommend the use of Salice hinge part number C2A6A99 110° with BAR3R mounting plate or similar.



Position the sliding block inside the track by rotating it 90°.

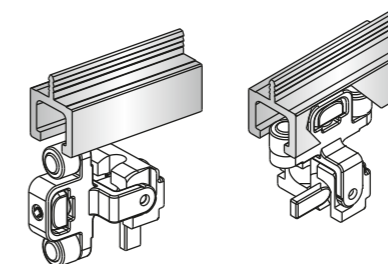

Lock the sliding block into position by turning the marked in orange lever.

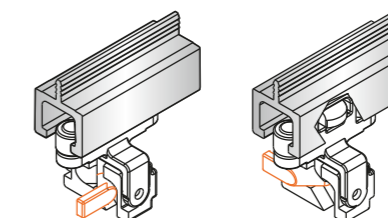

Application into the top of the cabinet and doors
Solution with barb-fix and screw-fix plastic track

Glass doors with the Practical system of aluminium-framed doors

Distance to be used when finger-protection strip and two-screw (D206BS5) or four-screw (D206BS5L) corner joint are used
 To facilitate the assembly of the doors on the cabinet, it is preferable to premount all the hinges.

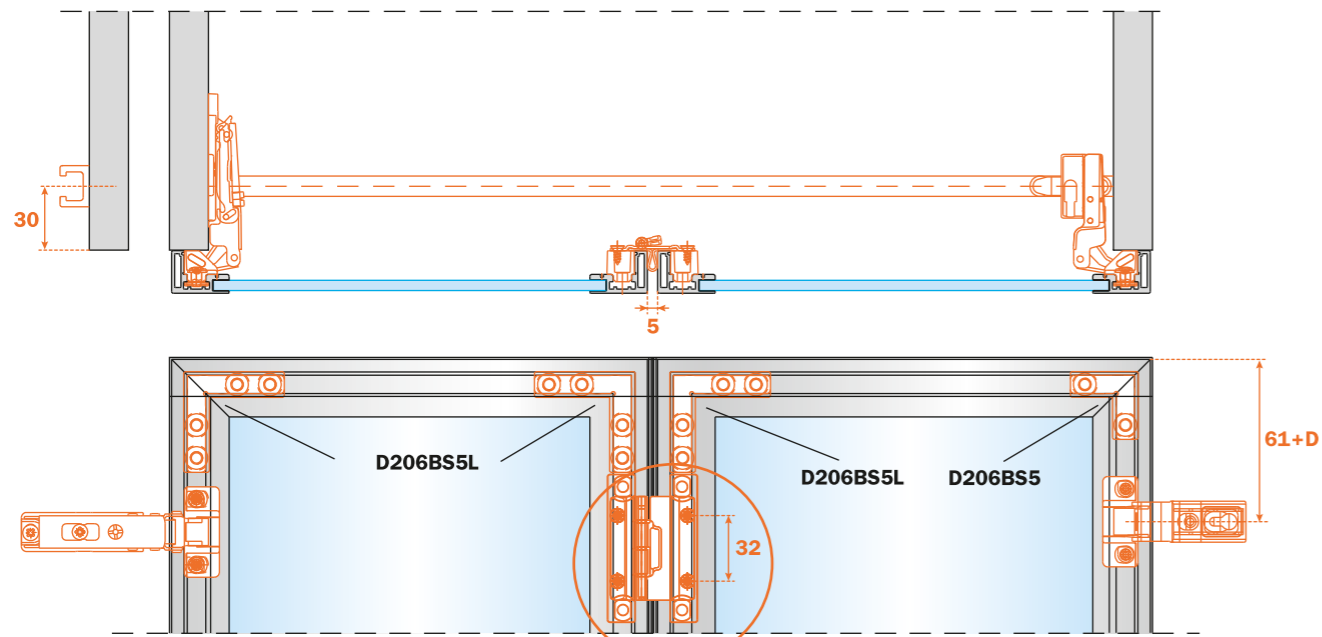

Central assembly:
 - narrow part to be mounted on the door which is fixed to the cabinet side;
 - wider part to be mounted on the moving door.

Glass doors with the Practical system of aluminium-framed doors

Distance to be used when finger-protection strip and four-screw corner joint (D206BS5L) are used
 To facilitate the assembly of the doors on the cabinet, it is preferable to premount all the hinges.

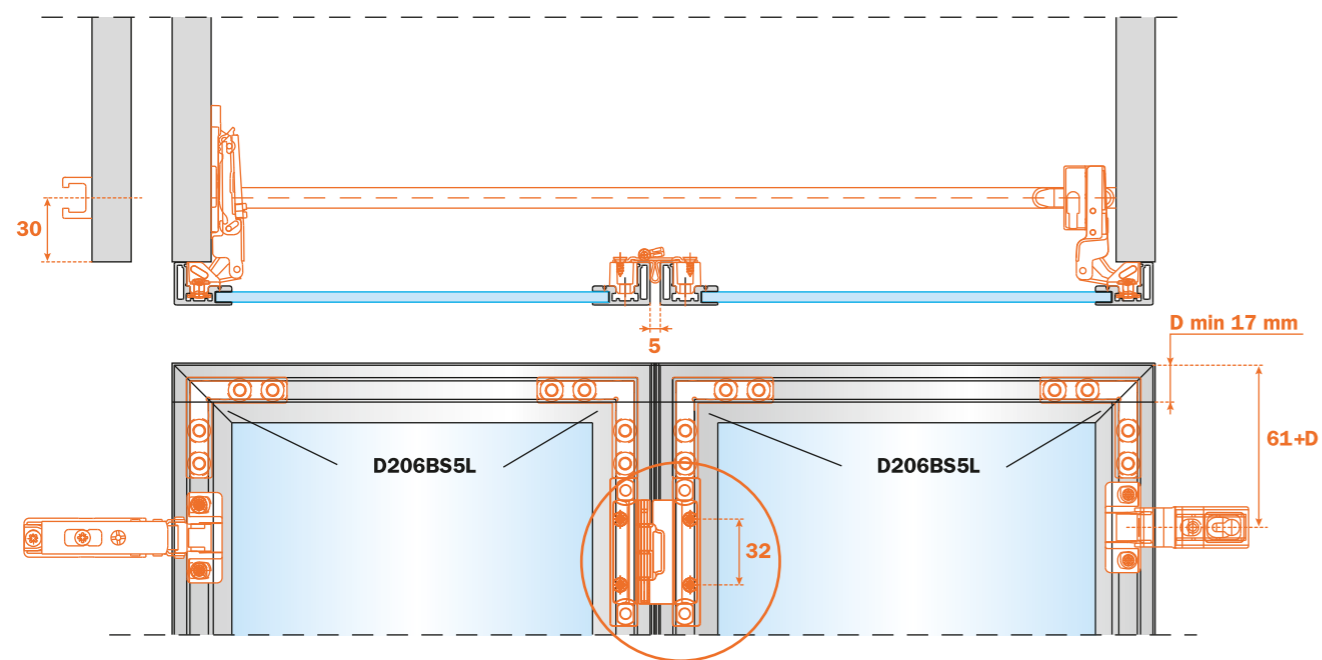

Central assembly:
 - narrow part to be mounted on the door which is fixed to the cabinet side;
 - wider part to be mounted on the moving door.

Packaging (standard packaging)

Elements of the system	Boxes	Pallets
F1C169	300 pcs.	7.200 pcs.
F1PXAY	300 pcs.	7.200 pcs.
F1CXE9	600 pcs.	14.400 pcs.
F1COE9	600 pcs.	14.400 pcs.
F1RFAY	300 pcs.	7.200 pcs.
F1CZ69	300 pcs.	7.200 pcs.
F1CA69	300 pcs.	7.200 pcs.
F1PVAY	300 pcs.	7.200 pcs.
F1C069	300 pcs.	7.200 pcs.
Adhesive finger-protection strip	200 metres	
Tracks 880 mm - 1180 mm	75 pcs.	
Tracks 590 mm	150 pcs.	

KIT - Packaging

F1C169	25 pcs.
F1PXAY	25 pcs.
F1CXE9	75 pcs.
F1GFA.....	25 pcs.
Available in 3 lengths	
and 4 colours	

Code number composition (example)

F1KFX3X880

